

Cat Series Relay Expansion Module

Installation / Setup Manual

CATRLY8



Select
Engineered
Systems, Inc.

CAT Series Relay Expansion Module

This page left intentionally Blank.

Table of Contents

Cat Series Auxiliary Relay Module

Introduction to Cat Series Relay Expansion Module	4
Description	4
Relay Code Addressing	5
Relay Activate Timing	6
Optional input and control terminals	7
Output Terminals	7
Wiring Connections	8,9
Individual Relay Times	10
Index	11

CAT Series Relay Expansion Module

The Select Engineered Systems Cat Series Relay Expansion Module.



Expansion Module
PC Board

The Cat Series Relay Expansion Module operates as a remote relay controller, with commands sent through a RS485 three wire loop from a CAT SERIES Unit ONLY. Telephone Access Unit will activate each of the Form C relays. Each code activated in the CAT SERIES unit will send four relay activation codes to the Auxiliary Module(s). The board may be selected to Fail Secure or Fail Safe.

Fail Secure means the relays are normally de-energized and energize on command. When power fails the relays remain de-energized not allowing a command.

Fail Safe means the relays are normally energized and de-energize on command to open. When power fails the relays de-energize forcing the command to open.

The relay outputs may be used to allow only certain elevator buttons to be used limiting access, additional doors to be unlocked controlling access and other functions as required. A local terminal block provides for local activation of the relays and additional hard wire programming, if required.

Each Cat Series Relay Expansion Module is individually assignable using simple rotary switches to an address range in steps of eight relays. The entire system allows for 32 boards to be connected for a maximum of 256 relays. Note: If two boards are set to the same address, the relays on BOTH boards would be activated.

The Cat Series Relay Expansion Module contains an timing selector 16 position rotary switch (SW2). If J23 & J24 are off, this switch set the activation time of all eight relays Switch Position 0 (shown) sets the activation time as 0 = 2 sec. Note: All times are ± 1 sec or $\pm 2\%$ whichever is greater.

The selector sets the same time for all relays on this board unless separate programming is used (See Page 10). The local terminal blocks provide opto-coupled control with the drive voltage provided. Terminals may be pulled to Circuit Common using dry relay contacts or transistor pull downs with 100 ohms or less. LEDs (Light Emitting Diodes) are provided to indicate input and output conditions as well as RS485 activity.

The Cat Series Relay Expansion Module requires power at 18VAC / 40VA. The output relays are rated 3 amps at 24V ac/dc.

A 12"L x 11.5"W x 3.5"H NEMA 1 enclosure is standard.

Standard Features for Cat Series Relay Expansion Module.

The Cat Series Relay Expansion Module contains an addressing selector 16 position rotary switch (SW1) and an addressing jumper J4. These addressing means set the address of the first relay activation code on the board and the other relays follow in consecutive order (Example: Switch Position 0 (shown) and J4 on, sets the activation codes as RLY0=000, RLY1=001, RLY2=002, RLY3=003, RLY4=004, RLY5=005, RLY6=006 and RLY7=007). **Removing jumper J4** would change the addressing to RLY0=128, RLY1=129, RLY2=130, RLY3=131, RLY4=132, RLY5=133, RLY6=134 and RLY7=135)

The Cat Series Relay Expansion Module contains eight relay Form C outputs. J5 set the relay action as J5-Off = Fail Secure (Relay is normally off and energizes on command) or J5-On = Fail Safe (Relay is normally on and de-energizes on command)

A0-A120

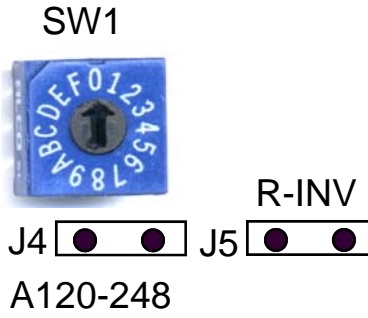

Addressing Selectors

Addressing Selector Switches		
J4	On	Off
Switch Position	First Relay Code	First Relay Code
0	000	128
1	008	136
2	016	144
3	024	152
4	032	160
5	040	168
6	048	176
7	056	184
8	064	192
9	072	200
A	080	208
B	088	216
C	096	224
D	104	232
E	112	240
F	120	248

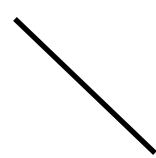
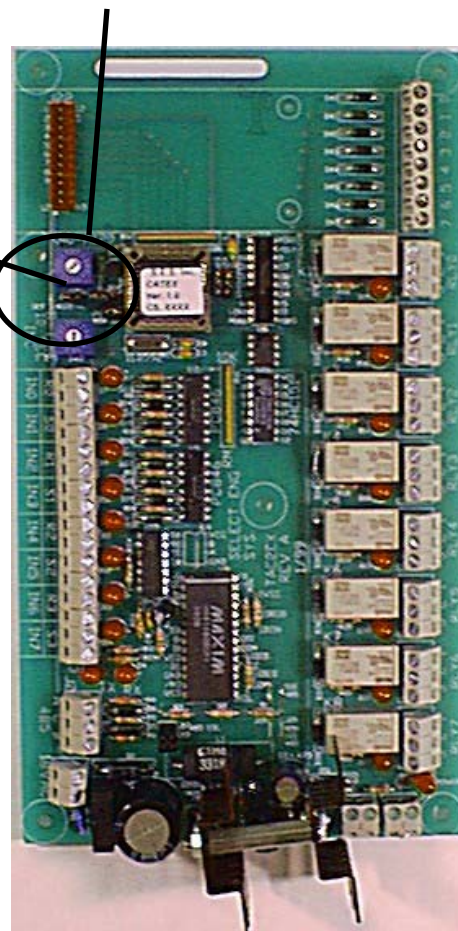

CAT Series Relay Expansion Module

INC
10 SEC
R-TIME
SW2
Timing Selector
J6



Standard Features for Cat Series Relay Expansion Module.

The Cat Series Relay Expansion Module contains an timing selector 16 position rotary switch (SW2) This switch set the activation time of all eight relays Switch Position 0 (shown) sets the activation time as 0 = 2 sec.

Timing Selector Switch	
Switch Position	Relay activate Time
0	2 sec
1	10 sec
2	20 sec
3	30 sec
4	40 sec
5	50 sec
6	60 sec
7	70 sec
8	80 sec
9	90 sec
A	100 sec
B	110 sec
C	120 sec
D	130 sec
E	140 sec
F	150 sec

Note: All times are ± 1 sec or $\pm 2\%$ whichever is greater.

The selector set the same time for all relays on this board. All relay outputs are one shot type activations. The relay will activate for the period of time indicated by the timing selector switch and then de-energize even if the input remains closed. The relay will not re-activate until the input is opened, then closed again. The input must remain closed for 150 ms min. for the relay to activate.

Standard Features for Cat Series Relay Expansion Module.

The CAT Series Something Module contains a terminal block (J16) that provides an logical low output for each relay output. They can be used to activate additional relay by connecting outputs to the IN(X) terminals.

Logical Output Block

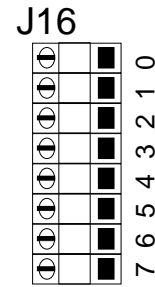

The Cat Series Relay Expansion Module contains a terminal block (J3) to individually activate all of the eight relays Terminal IN0 activates Relay 0 (RLY0) when the terminals are shorted or pulled to common. You may use dry relay contacts or transistor pull-downs referenced to circuit common. Each input has a LED located just to the right of the terminals to indicate when that input is on. When each input is closed the output relay will be activated for the time programmed by the Relay Timing Selector Switch and then the relay will return to its normal state *even if the input remains closed*.

Relay Activation	
Terminal ID	Relay Activated
IN0	RLY0
IN1	RLY1
IN2	RLY2
IN3	RLY3
IN4	RLY4
IN5	RLY5
IN6	RLY6
IN7	RLY7

Logical Input Block

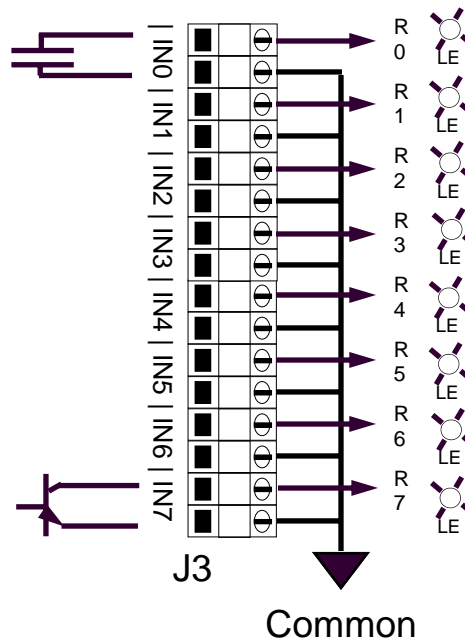

J7 located at the bottom of the board on the right side maybe used to turn off all the relays at once by opening the connection. This connector is normally shipped with a Jumper installed. This could be used with dry contacts opening on an external signal in conjunction with J5 settings (J5 connected is fail safe) to de-energize the relays during emergencies.

The relay outputs are type Form C (one normally open and one normally closed contact) rated at 3 amps 24 v ac/dc. Each relay has a LED (light emitting diode) next to it indicating when the relay is energized.

The BAT connections allow a backup battery to be connected. (SES Part No. B12V) This allows the unit to continue to operate during short power interruptions.

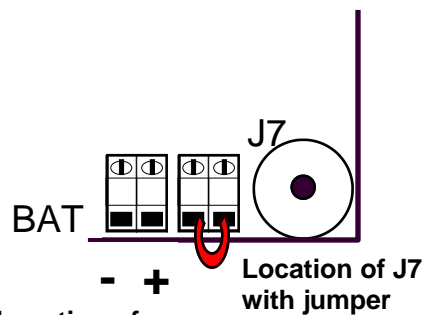

Location of J23 with Polarity Marks

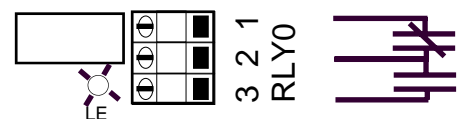

1-2 = N.C.
2-3 = N.O.

Example of relay output

CAT Series Relay Expansion Module

Standard Features for Cat Series Relay Expansion Module.

Wiring and interconnections

Power: 18 vac at 40 va. Plug in transformer supplied with unit.
 Connect at **J1** with 18 GA wire to a maximum of 100 ft and 14 - 16 GA to 200 ft.

RS485: the Cat Series Relay Expansion Module communicates with **CAT Series only**.
Recommended wire is Belden #8771. Attach from the CAT terminal barrier strip to J2 terminals as shown. Terminal 'A' is Red, Terminal 'C' is Black. Terminal 'B' is White. Note: Termination for the RS485 connections are provided. They must remain only on the LAST module connected. (If you are installing only one module, the Jumpers J17 J18 REMAIN).

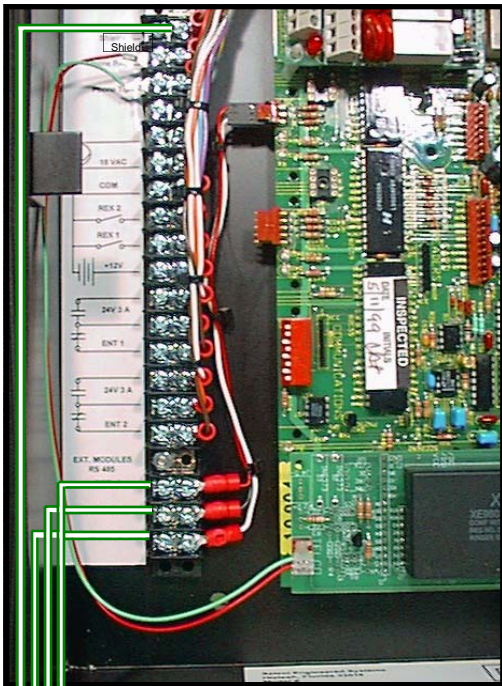

RS485 Connections to CAT Series Unit

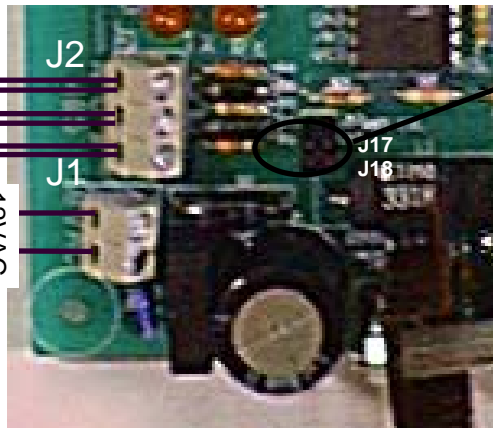
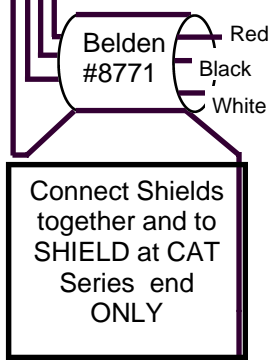

RS485 Connections Multiple modules - REMOVE Jumpers J17 J18

RS485 Connections LAST Module Jumpers REMAIN

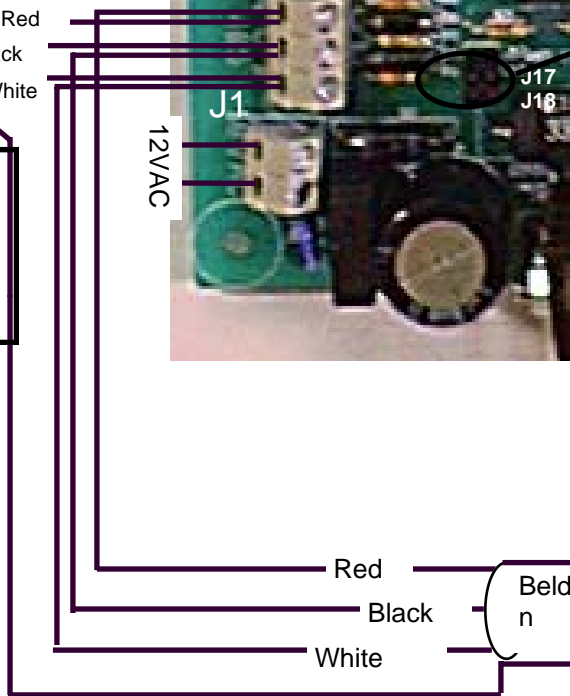

RS485 Connections to next Module

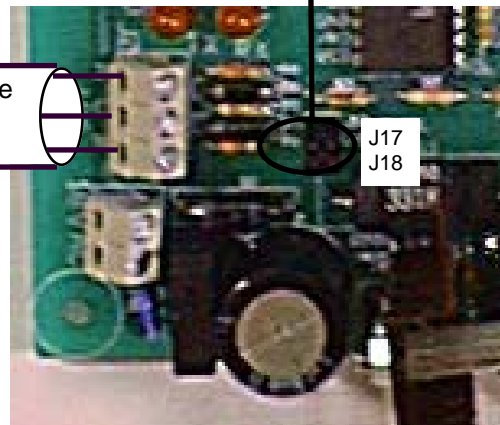

Model CATRLY8 Relay Expansion Module

Terminal Locations and Wiring Connections

Relay Active Timing Selector Switch		Addressing Selector Switches			
Sw Pos	Rly activate	J4 Sw Pos	On First Relay	J4 Sw Pos	Off First Relay
0	2 sec	0	000	0	128
1	10 sec	1	008	1	136
2	20 sec	2	016	2	144
3	30 sec	3	024	3	152
4	40 sec	4	032	4	160
5	50 sec	5	040	5	168
6	60 sec	6	048	6	176
7	70 sec	7	056	7	184
8	80 sec	8	064	8	192
9	90 sec	9	072	9	200
A	100 sec	A	080	A	208
B	110 sec	B	088	B	216
C	120 sec	C	096	C	224
D	130 sec	D	104	D	232
E	140 sec	E	112	E	240
F	150 sec	F	120	F	248

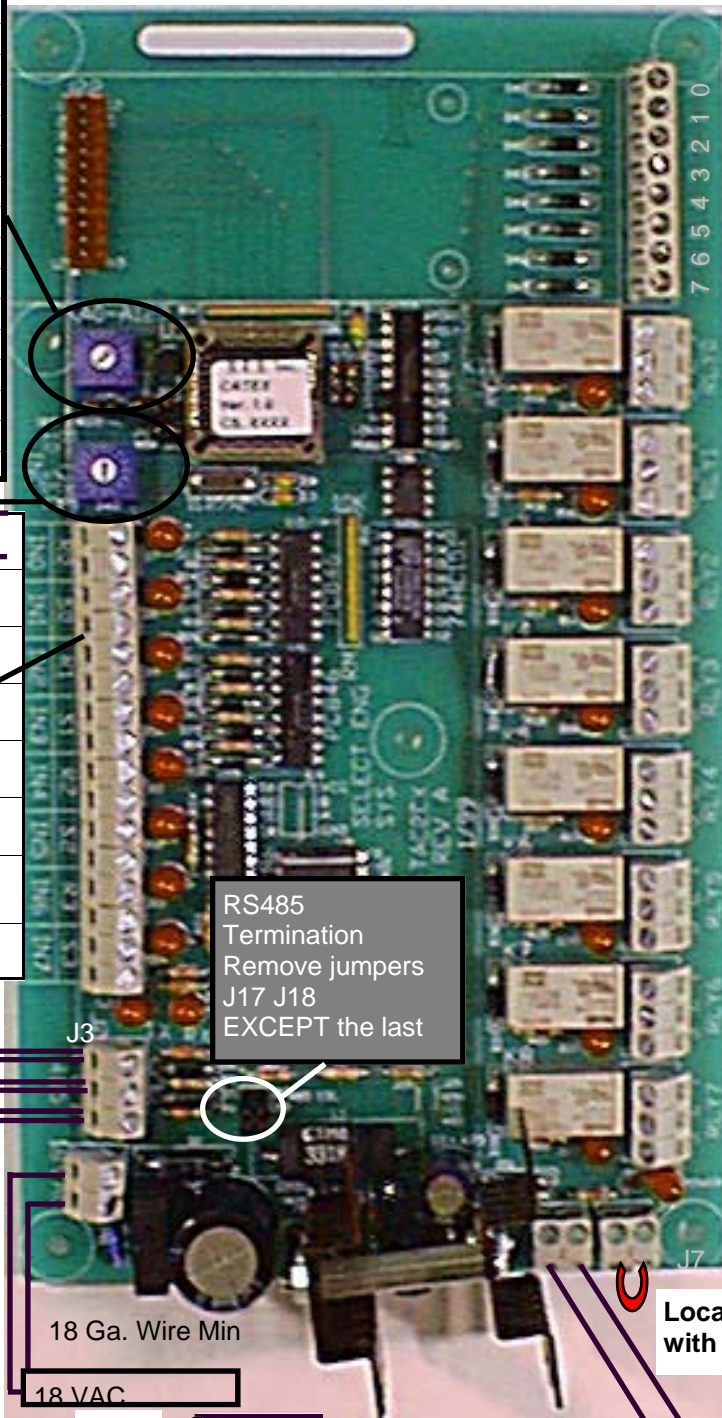

Logical low outputs for each relay. May be used with optional inputs to provide additional control logic.



1-2 = N.C.
2-3 = N.O.

Relay outputs rated at 3 amps
24v ac/dc

Optional Relay Activation		Terminal ID	Relay Activated
		IN0	RLY0
		IN1	RLY1
		IN2	RLY2
		IN3	RLY3
		IN4	RLY4
		IN5	RLY5
		IN6	RLY6
		IN7	RLY7

RS485 Termination
Remove jumpers J17 J18 EXCEPT the last

RS485 Connections to CAT Series

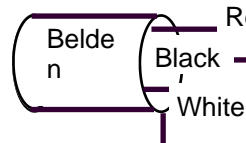

Connect Shields together and to Ground at CAT Series end ONLY

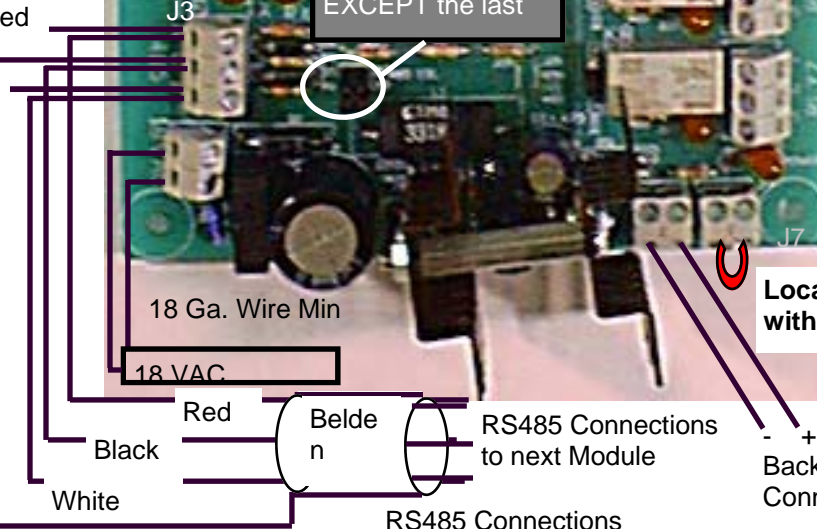

Location of J7 with jumper

Backup Battery Connections

CAT Series Relay Expansion Module

Jumper Function Table	
Relay times follow R-Time SW2	J23 - Off J24 - Off
Relay Times follow stored value	J23 - Off J24 - On
Program Relay Times Module not functional	J23 - On J24 - Off

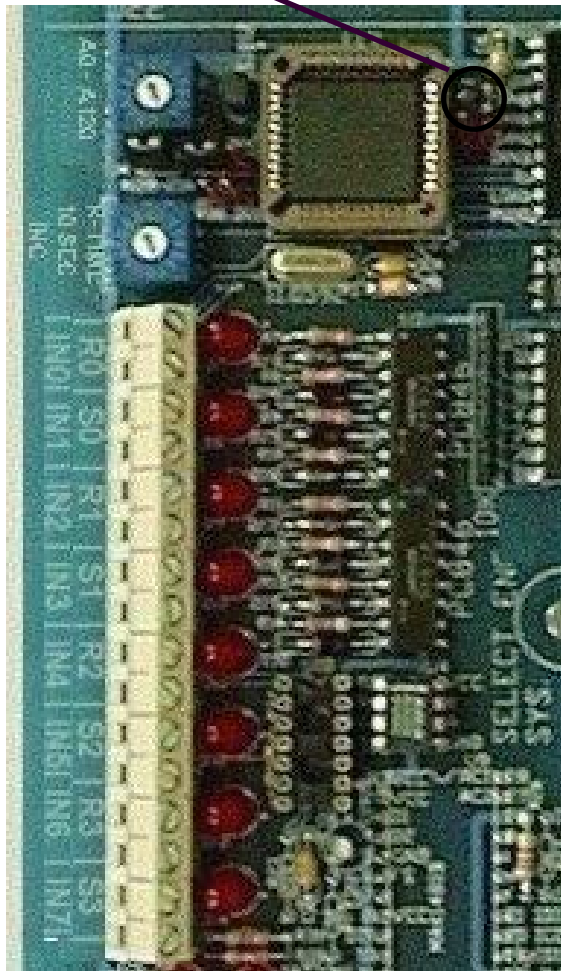
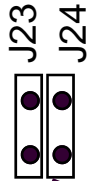

Standard Features for Cat Series Auxiliary Relay Module.

Individual Relay Times

The Cat Series Relay Expansion Module allows for programming individual relay times.

Programming relay times may be accomplished with Jumpers J23 and J24.

When Jumper J24 is installed the relay activate times become the stored values. The module is shipped with the default values of:

- RLY0 = 10 sec.
- RLY1 = 20 sec.
- RLY2 = 10 sec.

- RLY3 = 20 sec.
- RLY4 = 10 sec.
- RLY5 = 20 sec.
- RLY6 = 10 sec.
- RLY7 = 20 sec.

In order to change these values, follow these steps:

1. Move the jumper to J23 (On) with no jumper on J24 (Off).
2. Select the time desired on the R-Time switch (SW2).
3. Momentarily place a jumper across the input for the Relay to be set. The input LED should light.
4. Repeat 2 and 3 for all relays to be changed.
5. Move the jumper to J24 (On) with no jumper on J23 (Off).
6. The relays will follow the new program times.

INDEX

Board Address	5
Cabinet Size, Type	4
Code Addressing	5
Description	4
Fail Safe Configuration	5,7
Individual Relay Times	10
Index	11
Jumper, Relay	5,7
Power Connections	8
Programming Individual Relay Times	10
Relay Code Addressing	5
Relay Code Setting	5
Relay Timing	6
Relay Rating	4
RS485 Connections	8
RS485 Wire type	8
Size	4
Terminal Locations	9
Wire Type	8

CAT Series Relay Expansion Module

“BETTER TECHNOLOGY MAKES BETTER SYSTEMS”

11/08



***Select
Engineered
Systems, Inc.
7991 West 26th Ave.
Hialeah, FL 33016
Toll Free: 1-800-342-5737
In FL: 305-823-5410
Fax: 305-823-5215
www.selectses.com***